

PRELIMINARY ENGLISH TEST

Listening

Sample Paper**Time** Approximately 29 minutes**INSTRUCTIONS TO CANDIDATES**

Do not open this question paper until you are told to do so.

Write your name, centre number and candidate number on your answer sheet if they are not already there.

Listen to the instructions for each part of the paper carefully.

Answer all the questions.

While you are listening, write your answers on the question paper.

At the end of the test, hand in both this question paper and your answer sheet.

INFORMATION FOR CANDIDATES

There are four parts to the test.

Each question carries one mark.

You will hear each piece twice.

For each part of the test there will be time for you to look through the questions and time for you to check your answers.

Part 1

Questions 1 – 7

For each question, choose the correct answer.

1 What did the girl buy on her shopping trip?

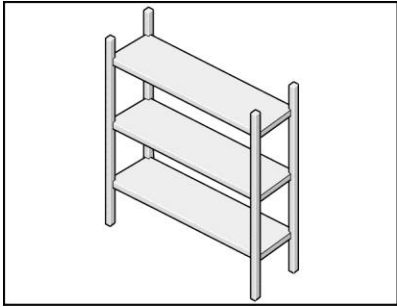

A

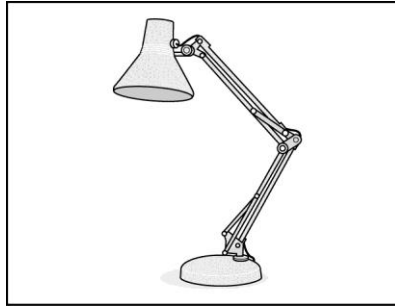

B

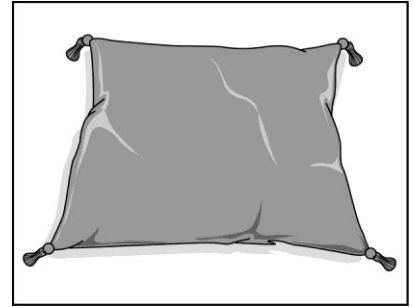

C

2 Why did the plane leave late?

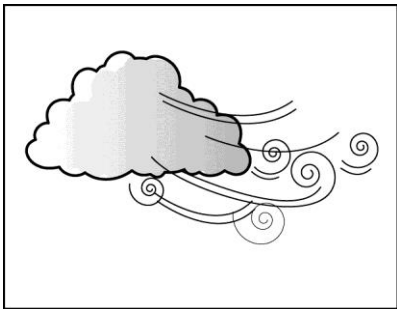

A

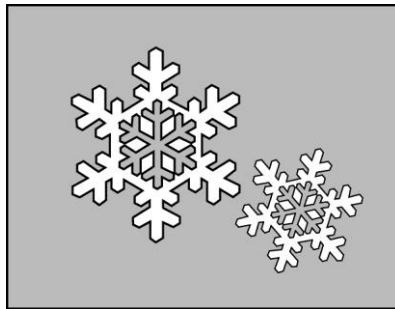

B

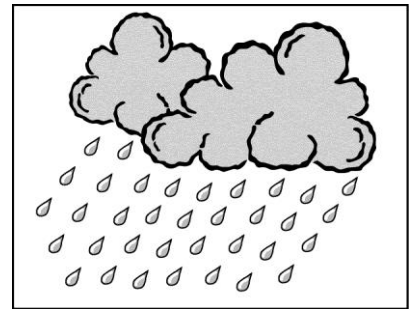

C

3 What activity does the woman want to book for the weekend?



A



B



C

4 Which cake will the girl order?

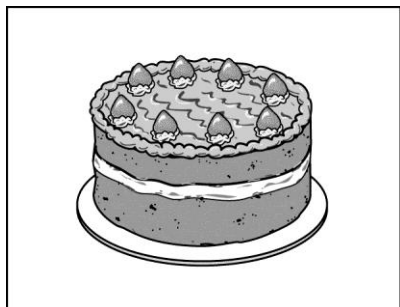

A

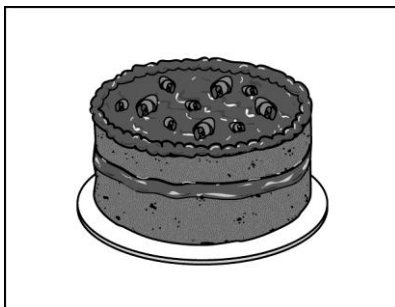

B

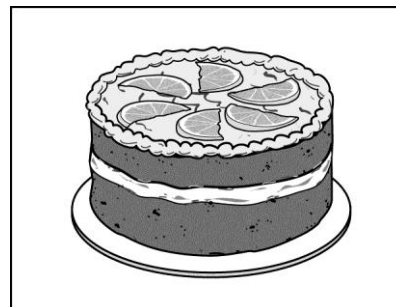

C

5 How much must customers spend to get a free gift?



A



B



C

6 What did the family do on Sunday?



A

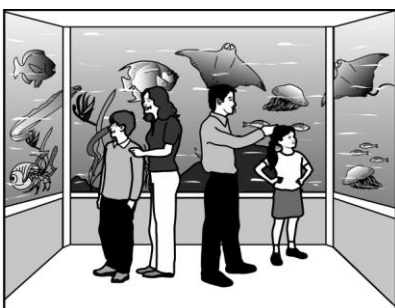

B

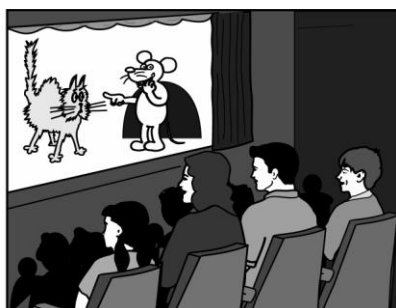

C

7 Which programme is on first?



A



B

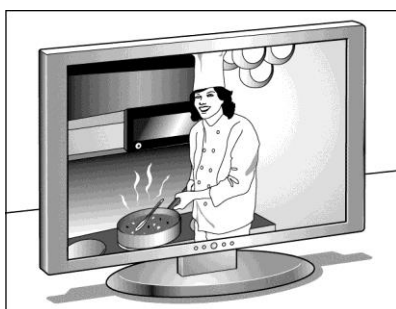

C

Part 2

Questions 8 – 13

For each question, choose the correct answer.

- 8** You will hear two friends talking about a new clothes shop
What does the girl say about it?
- A** The staff are helpful.
 - B** It only has the latest fashions.
 - C** Prices are reduced at the moment.
- 9** You will hear two friends talking about a pop band's website.
They think the site would be better if
- A** its information was up to date.
 - B** it was easier to buy concert tickets.
 - C** the band members answered messages.
- 10** You will hear a woman telling a friend about an art competition she's won.
How does she feel about it?
- A** upset that the prize isn't valuable
 - B** excited that the judges liked her picture
 - C** disappointed that she can't use the prize
- 11** You will hear two friends talking about the girl's flatmate.
The girl thinks that her flatmate
- A** is too untidy.
 - B** talks too much.
 - C** plays music too loud.

- 12** You will hear two friends talking about a football match.
They agree that their team lost because
- A** the players weren't confident enough.
 - B** they were missing some key players.
 - C** the players didn't do the right training.
- 13** You will hear two friends talking about a tennis match they played.
The boy wants the girl to
- A** help him to get fitter.
 - B** practise with him more often.
 - C** enter more competitions with him.

Part 3

Questions 14 – 19

For each question, write the correct answer in the gap. Write **one** or **two words** or a **number** or a **date** or a **time**.

You will hear a radio presenter called Anita talking about her holiday in Cuba.

ANITA'S HOLIDAY IN CUBA:

In the National Gardens, the (14) was the thing that attracted most people.

On the swimming trip, electronic armbands kept the (15) away.

On the day in the countryside, Anita almost fell off a (16)

In the capital city, Anita saw a (17) in a theatre.

Anita enjoyed visiting a farm where (18) is produced.

Anita bought some (19) as gifts.

Part 4

Questions 20 – 25

For each question, choose the correct answer.

You will hear an interview with a woman called Vicky Prince, a champion swimmer who now works as a swimming coach.

- 20** Vicky first went in for competitions because
- A** she had joined a swimming club.
 - B** her parents were keen on swimming.
 - C** her swimming teacher encouraged her.
- 21** As a teenager, Vicky's training involved
- A** exercising on land as well as in the water.
 - B** going without meals during the day.
 - C** travelling to a pool once a day.
- 22** What did Vicky find hard about her training programme?
- A** She couldn't go on school trips.
 - B** She lost some of her friends.
 - C** She missed lots of parties.
- 23** What helped Vicky to do well in the national finals?
- A** She was not expected to win.
 - B** She trained harder than usual.
 - C** She wanted to take a cup home.
- 24** As a swimming coach, Vicky thinks she's best at teaching people
- A** to deal with failure.
 - B** to improve their technique.
 - C** to get swimming qualifications.
- 25** Why has Vicky started doing long-distance swimming?
- A** She needed to get fit again.
 - B** She thought it would be fun.
 - C** She wanted to do some travelling.

BLANK PAGE